

USER MANUAL

Thermoelectric cooler

Model No:

BCW-25A BCW-25C

Thermoelectric cooler

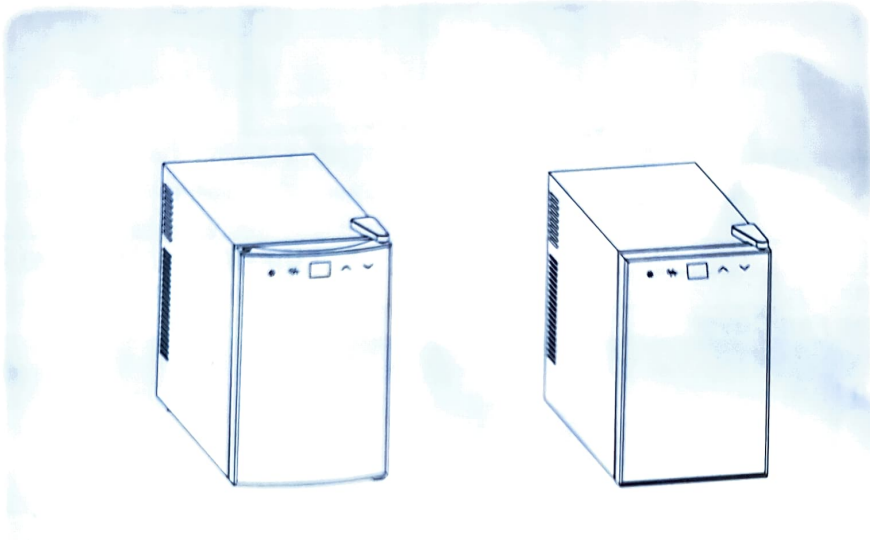

CONTENTS

•INDICATION OF PARTS.....	2
•TEMPERATURE CONTROL.....	3
•ELECTRIC DIAGRAM.....	4
•INSTRUCTION FOR USES.....	5
•VENTILATION	6
•TROUBLE SHOOTING GUIDES.....	6
•TECHNICAL DATA	7

WARNING: To avoid a hazard due to instability of the appliance, it must be fixed in accordance with the instructions.

WARNING: When positioning the appliance, ensure the supply cord is not trapped or damaged.

WARNING: Do not locate multiple portable socket-outlets or portable power supplies at the rear of the appliance.

This appliance is not intended for use by persons (including children) with reduced physical, sensory or mental capabilities, or lack of experience and knowledge, unless they have been given supervision or instruction concerning use of the appliance by a person responsible for their safety. Children should be supervised to ensure that they do not play with the appliance.

Thank you very much for buying this product. Before using your new cooler, please read this operation manual to ensure that you gain The maximum benefit from it.

• INDICATION OF PARTS

**BCW-25A
BCW-25C**

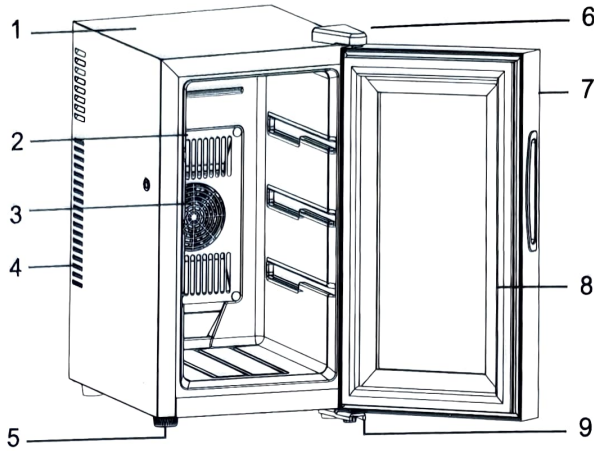

1. Cabinet	6. Upper Door Hinge w/ Cover
2. Cold sink fan	7. Glass Door
3. Cold sink Fan Cover	8. Gasket
4. Ventilation Holes	9. Bottom hinge
5. Leveling legs	

• TEMPERATURE CONTROL

It is recommended you install the Chiller in a place where the ambient temperature is between 23°-26°C/ 72°-78°F. If the ambient temperature is above or below recommended temperatures, the performance of the unit may be affected. For example, placing your unit in extreme cold or hot conditions may cause interior temperatures to fluctuate. The range of (8° -18° C/47°-64°F,BCW-25A/C.) may not be reached.

Temperature Ranges For Your Cooler







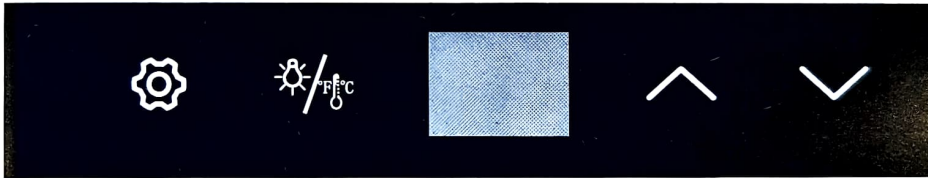

Temperature Range	8 - 18° C	47- 64° F	BCW-25A/C
-------------------	-----------	-----------	-----------

CONTROL PANEL

 You can select temperature display setting from Fahrenheit to Celsius degree by pushing this button for two seconds. Fahrenheit or Celsius degrees indicator will appear in white color in the LCD temperature display window with blue background.



• Temperature control

- You can turn the interior light ON or OFF by pushing the  button once. The light will be turned off automatically if it remains ON for 10 minutes. You have to push the  button again and the light will turn back on.
- You can select temperature display setting from Celsius to Fahrenheit degree by pushing the  button for 2 seconds.
 1. Your Cooler has been equipped with an "automatic" control panel lock, that will activate 20 seconds after the last time a button has been touched.
Push the  button for 2 seconds to unlock the control panel. You will hear a "BEEP" sound to alert you that the control is now active.
 2. You can set the temperature as you desire by pushing the  or  button on the control panel. The temperature that you desire to set will increase 1°C if you push the  button once, on the contrary the temperature will decrease 1°C if you push the  button once.

NOTE:

When you use the cooler for the first time or restart the cooler after having been shut off for a long time, there could be a few degrees variance between the temperature you select and the one indicated on the LCD readout. This is normal and it is due to the length of the activation time. Once the cooler is running for a few hours everything will be back to normal.

➤ **Interior Light**

You can turn the interior light ON or OFF by pushing the button marked with the "Light" symbol. 

The light will be turned off automatically if it remains ON for 10 minutes. You have to push the button marked with the "Light" symbol  again and the light will turn back on.

• ELECTRIC DIAGRAM

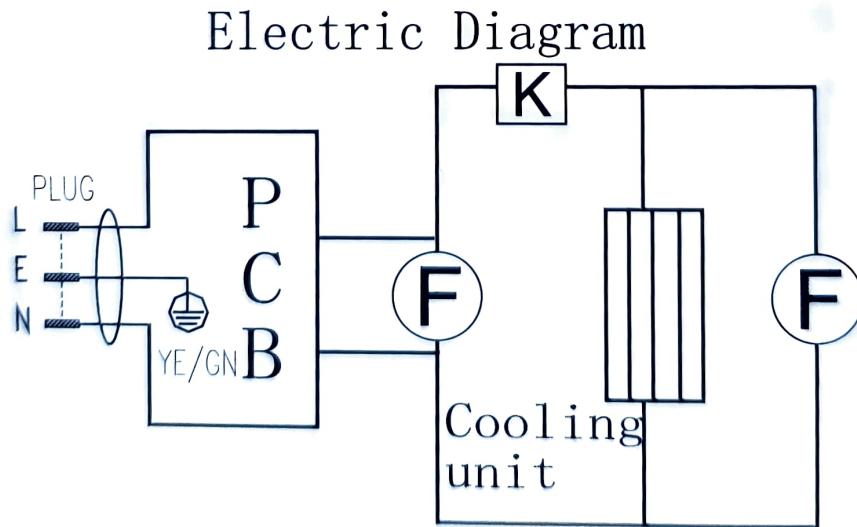

• INSTRUCTION FOR USES

1, Note

- 1, 1: Position your cooler so that the plug is accessible.
- 1, 2: Keep your cooler out of direct sunlight.
- 1, 3: Do not place next to heat generating appliance.
- 1, 4: Do not place directly on the ground. Provide suitable stand.

2, Very important:

- 2, 1: The cooler will have better performance at ambient of 20-25 degree; We suggest the cooler be powered off if the ambient temperature is lower than 10 degree.
- 2, 2: After plugging the appliance, allow the unit to cool down for 2-3 hours before placing beverage into the cooler compartment.
- 2, 3: Ventilation is very important for this kind thermoelectric cooler; The inside PCB will be broken easily if the ventilation is bad; It will also reduce the life of the cooler.
- 2, 4: If leakage occurs (which can be easily detected due to the unpleasant smell), please
 - A: Switch off the cooler immediately
 - B: Ventilate the room thoroughly
 - C: Call for the after sales service department
- 2, 5: These models use a thermoelectric cooling system with automatic defrosting system, so there is no need to defrost it manually.

3, Power supply:

- 3, 1: The cooler must be connected to a properly earthed socket in line with relevant valid country regulations before operating;
- 3, 2: Check the data label (which is on the side of the cooler) for voltage and frequency corresponds to your local one; If not, don't plug your cable into the socket;

• VENTILATION

When putting a TE cooler, ventilation should be considered seriously, please refer to the following:

- 1, there should be left at least 200 cm³ for ventilation
- 2, the distance between wall and cooler side should be at least 20mm
- 3, the back should be left at least 50mm for air flowing
- 4, air passing through must not be preheated
- 5, entire cooling system should be considered in the ventilation

• TROUBLE SHOOTING GUIDES

Failure: no cooling

Possible reason	Action
No power	Check the electricity supply, or change a new plug
PCB broken	Replace a new PCB
Fan broken	Replace a new fan
Leakage	Replace a new heat pump
Cooling module broken	Replace a new cooling module with silicone

Failure: poor cooling performance

Possible reason	Action
High ambient temperature	The room temperature is hotter than normal
Poor instruction	The door is opened too often
Poor ventilation	Install cooler according to our ventilation instruction
Poor gasket	Replace a new door gaske
Poor silicone	Change the silicone on the surface of the cooling module

Failure: noisy

Possible reason	Action
Dust	Clean the dust from the fan
Fan broken	Change to a new fan
Poor heat pump	Replace a new heat pump

WARNING:

1. This appliance is not intended for use by persons (including children) with reduced physical, sensory or mental capabilities, or lack of experience and knowledge, unless they have been given supervision or instruction concerning use of the appliance by a person responsible for their safety.
2. Children should be supervised to ensure that they do not play with the appliance.
3. This appliance can be used by children aged from 8 years and above and persons with reduced physical, sensory or mental capabilities or lack of experience and knowledge if they have been given supervision or instruction concerning use of the appliance in a safe way and understand the hazards involved. Children shall not play with the appliance. Cleaning and user maintenance shall not be made by children without supervision.
4. If the supply cord is damaged, it must be replaced by the manufacturer, its service agent or similarly qualified persons in order to avoid a hazard.
5. To avoid a hazard due to instability of the appliance, it must be fixed in accordance with the instructions.
6. When positioning the appliance, ensure the supply cord is not trapped or damaged.
7. Do not locate multiple portable socket-outlets or portable power supplies at the rear of the appliance.
8. Keep ventilation openings, in the appliance enclosure or in the built-in structure, clear of obstruction.
9. Do not use mechanical devices or other means to accelerate the defrosting process, other than those recommended by the manufacturer.
10. Do not use electrical appliances inside the drink storage compartments of the appliance, unless they are of the type recommended by the manufacturer.
11. Do not store explosive substances such as aerosol cans with a flammable propellant in this appliance.
12. Children aged from 3 to 8 years are allowed to load and unload refrigerating appliances.
13. This appliance is intended to be used in household and similar applications such as
 - staff kitchen areas in shops, offices and other working environments;
 - farm houses and by clients in hotels, motels and other residential type environments;
 - bed and breakfast type environments;
 - catering and similar non-retail applications.
14. To avoid contamination of drink, please respect the following instructions:
 - Opening the door for long periods can cause a significant increase of the temperature in the compartments of the appliance.
 - Clean regularly surfaces that can come in contact with drink and accessible drainage systems.
 - Clean water tanks if they have not been used for 48 h, flush the water system connected to a water supply if water has not been drawn for 5 days.
 - If the refrigerating appliance is left empty for long periods, switch off, defrost, clean, dry, and leave the door open to prevent mould developing within the appliance.

Note: This appliance contains flammable foaming agent cyclopentane. Please avoid contact fire when you transport and use it.

Please ask professional for servicing when the machine broke down.

Please send it to your local appointed disposal station when you discard it.

Failure: frost or ice inside minibar

Possible reason	Action
No defrost	Stop working for at least one hour, then restart it
Low ambient temperature	Adjust the air-conditioner to be around 25degree

• TECHNICAL DATA

Model No.	BCW-25A	BCW-25C
Net Capacity (liters)	21	21
Voltage (V)	220V	
Frequency (Hz)	60	
Rated Power (W)	65	
Dimension (mm)	252x500x453	252x500x453
Packing (mm)	290x540x480	290x540x480
Net Weight (kg)	9.5	9.5
Gross Weight (kg)	11.0	11.0
Approval	CB/ CE	

Correct disposal of this product



This symbol on the product, or in its packaging, indicates that this product may not be treated as household waste. Instead, it should be taken to the appropriate waste collection point for the recycling of electrical and electronic equipment. By ensuring this product is disposed of correctly, you will help prevent potential negative consequences for the environment and human health, which could otherwise be caused by the inappropriate waste handling of this product. For more detailed information about the recycling of this product, please contact your local council, your household waste disposal service, or the shop where you purchased the product.